



SIA Software Company, Inc.

*What exactly does the Delay Locator do?*

*What is the Delay Locator used for?*

*How does it work?*

*Obtaining the best results from the Delay Locator*

## Using The SIA-Smart Pro Delay Locator

The SIA-Smart Pro Delay Locator (a feature of the Real-Time module) is used to calculate the *impulse response*\* of a device or system under test. There are two common purposes for making this measurement:

- ▶ To find the delay between two input signals — the impulse response shows the precise delay time through electronic devices and/or between a loudspeaker and microphone position. This information can be used to align the signals for a Transfer Function measurement, to set up a delay unit, etc.
- ▶ To collect acoustical information about a system/room for detailed analysis in the SIA-Smart Pro Analysis module — an impulse response contains a large amount of information about a room including arrival times of reflections and the decay of the reverberant field.

The Delay Locator calculates the impulse response mathematically, using two input signals from a *continuous* signal source. The mathematical technique used assumes that each of the two computer sound inputs is receiving the same signal but that the two signals are traversing different signal paths as in *Figure 1* below.

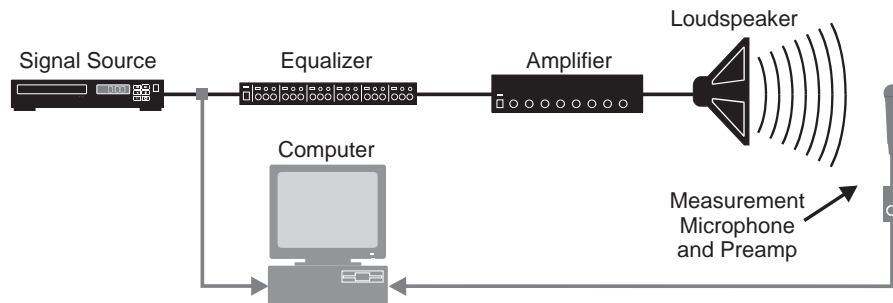

Figure 1: Typical Test Setup for Delay Locator Measurements

In this discussion we will focus on measuring delays but regardless of the purpose for making the measurement, the measurement process is identical and the following procedures can help you to obtain the best possible results.

- ▶ Start with the Real-Time module in the 2-Channel (conventional real-time analyzer) mode. Ensure that the *Reference* (source) signal is on input channel #1 (represented by the light blue trace in the default display color scheme), and that the *Measurement* signal — the system output as returned by the microphone in Figure 1 above — is on input channel #0 (represented by the light green trace in the default color scheme).

\*For the purposes of this discussion, the impulse response of a system can be defined (non-mathematically) as the signal that describes the changes a reference signal undergoes as it travels through the system.

**Bring up the noise**

**Match the input amplitude levels**

**Set up Delay Locator input options**

**More averaging yields a better signal-to-noise ratio**

**Sampling rate determines the frequency content**

**Make sure the FFT Time Constant is large enough**

**Start the Delay Locator**

- ▶ Start the signal source — typically a noise generator or CD player playing pink noise or music — and set the gain of the sound system to a useful level to excite the room.
- ▶ Adjust the input levels to the computer so that both traces in the 2-Channel mode are as close in amplitude as possible. When using Pink noise or other signals with transient components (i.e. high crest factor signals), **set the gain of the system so that both signals are registering about -12 dB** on the Real-Time module's input level meters. This helps to ensure that near-instantaneous peaks in the signals will not overload the input section of the sound card's A/D converter.
- ▶ Enter Delay Locator mode, by pressing **L** or clicking the Delay Locator button on the top toolbar. Examine the Locator's input options on the input bar above the plot. You will need to set three input values before making a measurement.



- **Frame(s):** The Frames value determines the number of FFT frames the delay locator will record when you press the **Start** button. If a value of more than 1 is selected, the specified number of frames are recorded and averaged together to calculate the impulse response. **With every doubling of the number of the number of frames averaged, the signal-to-noise (S/N) ratio of the impulse response calculated will increase by 3 dB** — the trade-off is that it takes longer to record and process the data.
- **SR (Sampling Rate):** The sampling rate to be used to record the data for the FFT. The sampling rate determines the frequency content of the measurement in that the highest frequency obtainable at a given sampling is equal to one half of the sampling rate (the Nyquist frequency). As a general rule, you will probably want to use a sampling rate of 44100 or greater to obtain a full-bandwidth impulse response. A lower rate might be preferable when measuring a subwoofer system, a band-limited system, or a room/system with a decay time significantly longer than 3 seconds.
- **FFT (size):** This value specifies the size (in samples) of the Fast Fourier Transform (FFT) used in the delay locator calculations. Together with the *Sampling Rate*, the *FFT size* determines the length of the *FFT Time Constant* or “time window” for the measurement. ( $FFT\ Size\ divided\ by\ Sampling\ Rate = FFT\ Time\ Constant$ ).

To obtain a valid measurement, **it is critical that the FFT Time Constant be longer than the decay time of the system under test.** For acoustic measurements that typically means the decay of the room. Most rooms have a decay time considerably less than one second but when in doubt, go longer. The only downside to having an time window that is too *large* is the extra time it takes to record and process the measurement data.

- ▶ After you have set up the appropriate input parameters, click the **Start** button located below the input level meters on the right. The Delay Locator records and processes audio data then displays a time-domain plot of the system's impulse response.

### A typical small room impulse response plot

- Although no two rooms will have an identical impulse response, the result of an acoustic measurement (made using a microphone) will probably look something like *Figure 2* below when viewed using decibel (logarithmic) amplitude scaling.

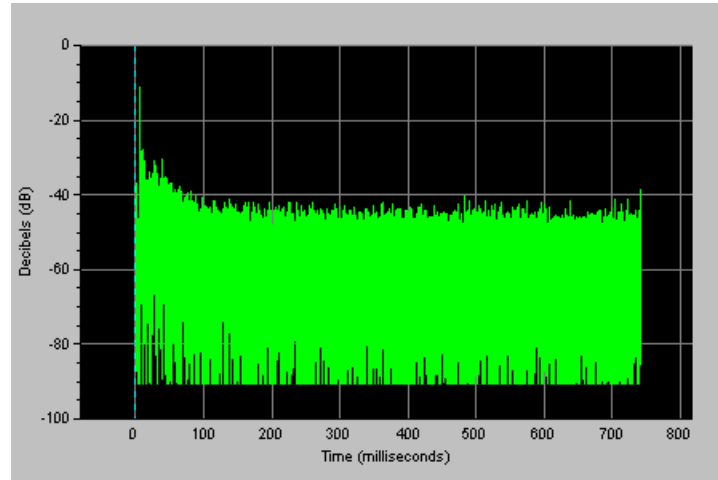

*Figure 2: Typical impulse response of a small room. Note the prominent “spike” at approximately 6 milliseconds (near the left side of the trace).*

### Finding the delay time

- The first big peak in the trace represents the “first arrival” or “direct sound.” By default, the Real-Time module will mark the location of the highest peak in the trace with a Locked Cursor (see *Figure 3* below) to give you the precise propagation delay through the system. The locked cursor readout shows both time and amplitude coordinates for the peak as well as the absolute polarity (+ or -).

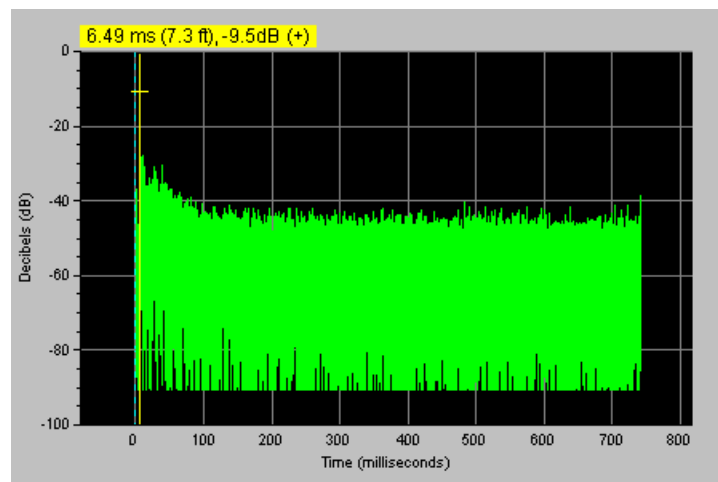

*Figure 3: The Locked Cursor (in yellow) identifies the time location of the first arrival (the total propagation delay through the system, across the room, to the microphone). The locked cursor readout above the plot shows time and amplitude coordinates for the peak.*

If you like, you can examine the peak structure in greater detail by “zooming in” on the time scale. To zoom in, place your mouse cursor on the peak and click with the left mouse button. Repeated mouse clicks will increase the

*Zooming in on the time scale plot for greater detail*

“magnification” or use the arrow keys to zoom in and out and move left and right along the time scale. To zoom back out to the full (time) scale display of the impulse response, click anywhere in the Delay Locator Window *outside* the plot area.

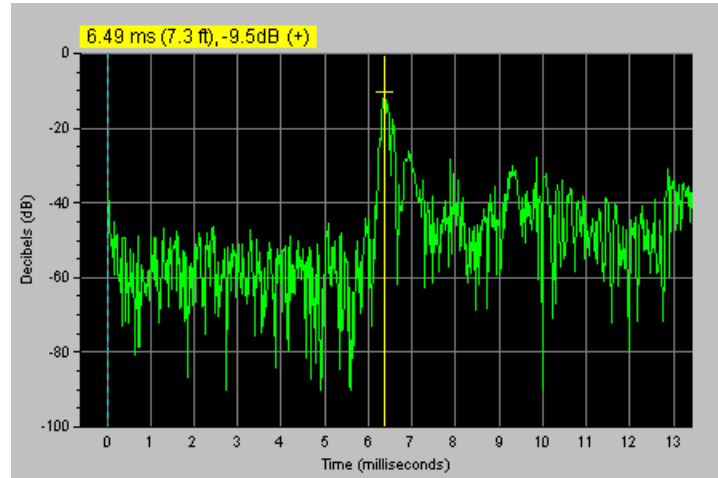

Figure 4: By zooming in on the time scale of the room impulse response in Figure 3 (on previous page) the peak structure can be examined in great detail.

*Setting up the internal delay for a transfer function measurement*

*Saving the measured delay time for quick recall*

*Electrical measurements*

- ▶ To set the Real-Time module’s internal delay to the delay time indicated by the locked cursor, hold down the Control (Ctrl) key while pressing the space bar on your keyboard. This action opens the *Delay Options* dialog box with the locked cursor location already entered as the Delay Time value.
- ▶ At this point it is a good practice to assign the delay time to one of the five Delay “Preset” registers labeled *F6*, *F7*, *F8*, *F9*, and *F10* (*F5* is reserved as a hot key for “bypass,” or 0 ms delay). To do this, simply click one of the “Assign Time to Preset” buttons with your mouse. If you assign the delay time to the *F10* preset register, for example, you can recall it at any time simply by pressing the *F10* key on your keyboard.
- ▶ To combine the previous two steps in a single command, use shortcut keys Ctrl + F6 - F10. For example, holding down the Ctrl key and pressing F10 will automatically set the current delay time for the program’s internal delay to the locked cursor value, assign the same value to Delay Preset F10, and exit the Delay Locator, returning you to Analyzer mode.
- ▶ The maximum delay SIA-Smaart Pro provides internally is 500 milliseconds. If you need to make a synchronized transfer function measurement of a system with a propagation delay longer than 500 milliseconds (e.g., measuring a loudspeaker with a microphone 600 ft. [183 m] away), an external delay is required.

#### **Measuring Electronic Devices:**

Determining the throughput delay, of an electronic device or system such as a digital delay or digital system controller involves very much the same procedure except that both measurement points are *electrical*. Again, the output of a signal

source is split (typically using a Y-cable), sending one branch into computer sound card input 1 as the *Reference* signal. The other branch is sent to the device or system under test as before. However, in this case the output of the device(s) being measured is brought *directly* back to sound card input 0 (without traveling through an amp and loudspeaker to a microphone) as the *Measurement* signal.

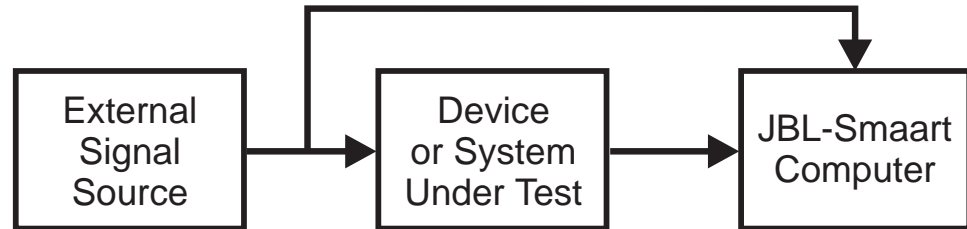

Figure 5: Block diagram of a typical test setup for use with SIA-Smaart Pro in performing Delay Locator and Transfer Function measurements

Since both signal inputs are electrical, unless you are measuring a reverb unit the impulse response will typically show a single spike with a very high S/N ratio and without the reflections and slow decay characteristic of acoustic measurements (made using a microphone). *Figure 6* below shows the impulse response of a digital delay unit set to 10 milliseconds on the front panel. As it turns out, this unit has a latency, or throughput delay of 0.9 ms so the total delay through the unit is actually 10.9 ms as measured by the Delay Locator — a useful thing to know!

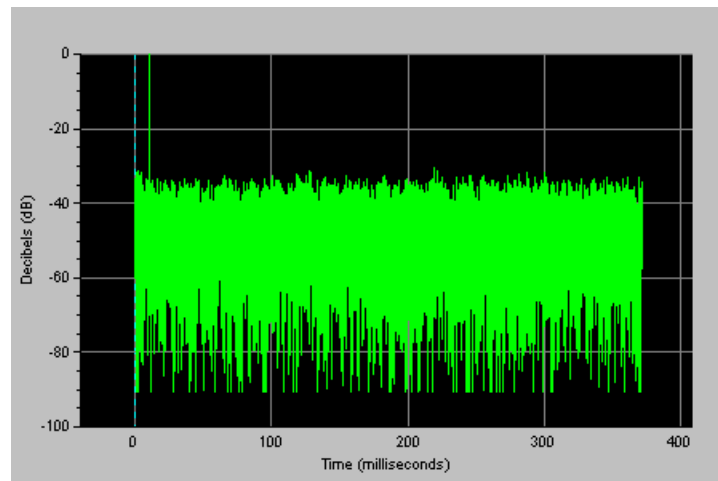

Figure 6: Delay Locator plot of a digital delay unit.

*The Impulse Response of an electronic device*

*Common problems and possible solutions*

### ***Troubleshooting the Delay Locator:***

Problems with the SIA-Smaart Pro Delay Locator typically fall one of three categories:

- *Reference* and *Measurement* signal inputs are swapped
- Poor Signal-to-Noise ratio
- Too short an FFT time constant (time window)

**“Why does the Delay Locator say the microphone is half a kilometer from the loud-speaker?”**

**“Where is the room acoustics information?”**

## Inverted inputs

The first of the three, swapped inputs, is the easiest to detect and correct. If the inputs are inverted so that the *reference* signal is arriving at input 0, where the program expects to find the *measurement* signal (and vice versa), the resulting trace in the Delay Locator is “wrapped around.” The peak will appear on the *right* side of the trace, appearing to indicate an *extremely* long delay time (and will typically show poor signal-to-noise). To correct this problem, you can either:

- ▶ Swap the two input signals externally (recommended) by physically swapping the cables or inverting the pan controls if you are using an external stereo mixer to control the inputs to the computer (also recommended), or
- ▶ Click the Swap button on the Delay Locator toolbar to transpose the input signals internally. If you choose this option and intend to make Transfer Function measurements, remember to also swap the Transfer Function inputs and assign any internal signal delay used to synchronize the two input signals to *Channel 0* rather than Channel 1.

*Note:* A similar (but rare) problem occurs when there is a delay on the *Reference* signal relative to the *Measurement* signal. This can usually be avoided simply by bringing the reference signal to the computer by the most direct route possible.

## Signal-to-Noise Problems

A poor signal to noise ratio is also easy to detect when you know what to look for. *Figures 2 and 3* on page 3 show an acoustic measurement with good signal-to-noise. *Figure 7* below shows the same measurement with a very poor S/N ratio.

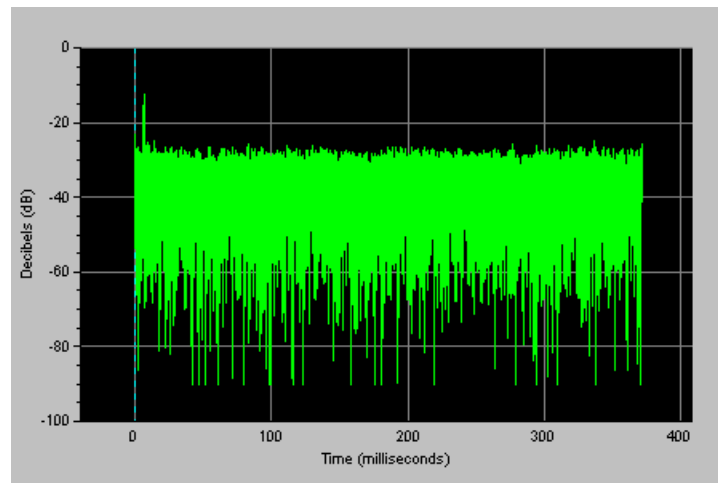

*Figure 7: An acoustic measurement with a poor signal-to-noise ratio*

Notice that the top of the peak is less than 15 dB above the noise floor and none of the reflection and decay information about the room is visible. Although the peak is sufficiently clear for simply setting the delay time, this measurement would be useless for acoustical analysis purposes. Also, the poor signal-to-noise ratio may indicate a problem exists that should be corrected before performing real-time Transfer Function measurements of the system’s frequency response.



---

***Improving the  
signal-to-noise  
ratio of a  
measurement***

Poor signal-to-noise has several possible causes and solutions:

- ▶ In acoustic measurements, a possible cause for the problem is that you simply are not making enough noise to “overpower” the ambient noise in the room. It may be desirable to increase the output of the loudspeaker(s) used to stimulate the room. Ideally, the stimulus sound pressure level should be 70 dB or more above the noise floor of the room.
- ▶ You can also improve the S/N ratio of a measurement by increasing the *Frames* value (on the Input Bar above the plot area). For every doubling of the number of frames averaged, the measurement will gain 3dB more signal to noise. This is particularly useful in noisy rooms and/or when you must keep your own noise levels to a minimum. The only trade-off is the additional time it takes.
- ▶ Another possibility is that the input signals to the computer may be mismatched or too low in level to overpower the self-noise of the computer sound card. Always make sure the two signals are approximately even in amplitude in 2-Channel mode and registering about -12 dB on the input level meters before running the Delay Locator.
- ▶ If you are using a notebook or other computer with an internal microphone, make sure it is disabled. If the internal microphone is open, its signal can contaminate all types of measurements. A simple test for this is to disconnect all external inputs, run the Real-Time module in 2-Channel mode and whistle directly into the internal microphone. You should see no reaction to any sound you make in either of the two traces or on the meters.

In Windows 95, most sound hardware utilizes Microsoft’s standard *Volume Control* mixer utility. If your internal microphone is open, you should be able to disable it using the procedure below.

- Open Volume Control — *double-click* the little speaker icon in the “system tray” on the right of the Windows Taskbar or click the *Start* button (on the left) and select *Programs > Accessories > Multimedia > Volume Control*.
- In the Volume Control application, select *Properties* from the *Options* menu.
- In the properties dialog box, lick the *Recording* “radio button,” make sure the boxes for *Microphone* and *Line-In* are checked in the list below, and click *OK* to exit the dialog box. The title of the Volume Control window should now read *Recording Control* and you should see a different set of “faders.”
- Uncheck the *Select* box under the *Microphone* fader to disable the input. And while you’re there, make sure the *Select* box for the *Line-In* input is checked, confirm that the balance control is centered and the fader is set to a useful level. If you like, you can leave the Recording Control application in case you want to make further level adjustments or you can close it.

*Note:* A small number of Smaart Pro users have reported that they were unable to completely disable their internal microphone via software. In this case, it may be possible to disconnect the internal microphone electrically by inserting a dummy plug into the external mic. input jack. Consult your computer/sound card documentation or contact the manufacturer for more information.

---

***Disabling  
the internal  
microphone***

*Determining  
the proper time  
window for a  
measurement*

*When in doubt,  
go longer!*

## FFT Time Constant Too Short

When you clap your hands in a room the energy does not dissipate instantly (unless the room happens to be an anechoic chamber) but falls off over a period of time that varies according to the room's size and other acoustic characteristics. That period of time from when the stimulus ends until the noise reaches a level that is indistinguishable from the background noise is called the room's *decay time*. To obtain a valid Delay Locator measurement, **it is critical that the *FFT Time Constant* used be longer than the decay of the system under test.**

If the time window (FFT time constant) you are using is too short, the result is analogous to throwing a hard rubber ball in a small concrete room. When the ball slams into a wall it still has energy and nowhere to go but back until it hits another wall and so on until its energy is exhausted. Hold that picture in your mind for a moment and look at Figure 8 below.

The only difference between this measurement and the way the measurement shown in *Figure 2* (on page 3) was made is the size of the *FFT Time Constant*. In, *Figure 2* the *FFT Time Constant* was set large enough to contain the entire impulse response of the room/system — using the analogy above, the “room” was large enough for rubber ball to continue in one direction until it exhausted its energy and gently rolled to a stop. In *Figure 8*, it was not.

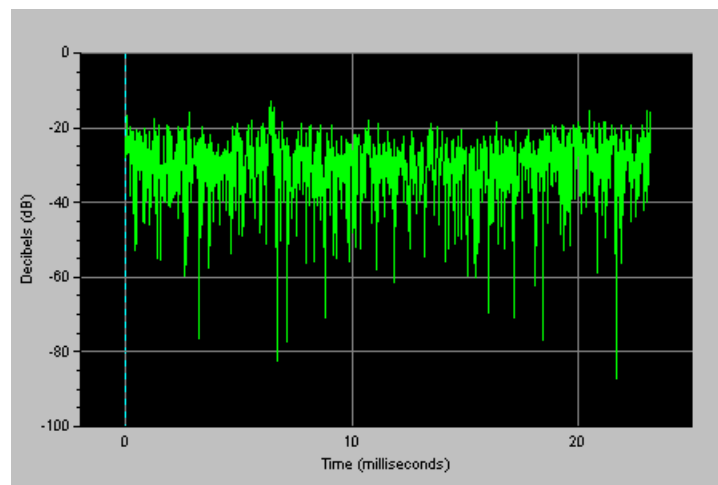

*Figure 7: An example of a Delay Locator measurement made with an FFT Time Constant (time window) that is smaller than the decay time of the room.*

You can actually still see a barely-distinguishable peak at about 6.4 milliseconds if you know where to look. It is, however, by no means clear enough to consider the data trustworthy for delay setup or any other purpose.

On the other hand, the only real penalty to using an FFT Time constant that is too *long* is the additional time it takes to collect and process the additional data. The difference usually amounts to a few seconds and you should pick up a little extra signal to noise in the process. So again, a good rule of thumb is when in doubt, go longer.



*Note:* One other possible downside of using an overly long time window — if the impulse response is being recorded for acoustical analysis — is that a larger file will take longer to load, transform and display in the SIA-Smaart Pro Analysis module. A simple work-around is to use the Analysis module's *Save Wave Zoom As* feature to make a new file with some portion of the extra “noise tail” deleted before analysis.

### **Other Common “Operator Errors”**

The following was compiled from several recent technical support calls. They may seem obvious but we feel they're worth mentioning:

- ▶ Forgetting to clear the internal delay before making a measurement. Don't laugh, it's not hard to do — especially when you are first learning Smaart Pro and/or have a lot of other things on your mind.
- ▶ Mixed input signals — if you are measuring the delay, for instance, between a loudspeaker and a microphone position and you keep getting a strong spike at time zero, check your input setup.
  - Are the reference and measurement inputs panned hard in opposite directions?
  - Could one signal be getting mixed with the other through an aux/effects bus?
  - Are any inputs being driven to the point excessive crosstalk might occur?
- ▶ Neglecting to account for delay through digital devices — if the delay locator is telling you a microphone is a foot or two farther from a loudspeaker than you know it really is, look at the signal chain. Is there a digital EQ, mixer, or system controller in line that could be adding a millisecond or two of delay? In general, what you are actually concerned about is the total delay through the system so it may not really matter but it can be a little disconcerting.

Also, keep in mind that the speed of sound varies with air temperature. The Real-time module uses a fixed value of 1120 feet (341.359 m) per second to calculate distance equivalents for time values. Over long enough distances, small changes in speed can add up to noticeable differences in the distance readings.



A Publication of SIA Software Company, Inc.  
One Main Street  
Whitinsville, MA 01588  
USA

telephone: 508-234-6158  
e-mail: support@siasoft.com  
www.siasoft.com

Copyright 1999 SIA Software Company, Inc. All rights reserved.